

Formulate Tablet Kiosk - 02

TABLET-STD-02

Sleekly-designed free standing tablet stands and kiosks make it easy to encourage interactivity, present information and engage your customers in any space.



features and benefits:

- State-of-the-art 30mm aluminum tube frame with sturdy internal spigot assembly
- Easy to store and ship
- Quick to set up
- Kit includes: one frame, one dye-sublimated zipper pillowcase graphic, tablet holder, and one wheeled molded OCH2 storage case
- Lifetime hardware warranty against manufacturer defects

dimensions:

Hardware	Graphic
<p>Assembled unit: 20.248" w x 85.106" h x 23.797" d 514mm(w) x 2162mm(h) x 604mm(d)</p> <p>Approximate weight (includes graphic): 19.65 lbs / 8.9 kg</p>	<p>Total visual area: Front: 17" w x 87" h Back: 34" w x 86.25" h</p> <p>Front panel has obstructions for tablet. This space will be covered.</p> <p>Please be sure to include 2" bleed around the perimeter.</p>
Shipping	<p>Refer to related graphic template for more information.</p> <p>Visit: www.exhibitors-handbook.com/graphic-templates</p>
<p>Shipping dimensions: 1 OCH2 case: 18" l x 18" w x 40" h up to 66" h 457mm(l) x 457mm(w) x 1016mm(h) up to 1675mm(h)</p> <p>Approximate shipping weight (with case): 50 lbs / 23 kg</p>	

additional information:

Graphic material:
Dye-sublimated zipper pillowcase fabric

Tablet not included

*Tablet holder compatible with 2nd and 3rd generation iPad tablets only.



www.display-setup-animations.com

We are continually improving and modifying our product range and reserve the right to vary the specifications without prior notice. All dimensions and weights quoted are approximate and we accept no responsibility for variance. E&OE. See Graphic Templates for graphic bleed specifications.

Parts Included

Part Label	Qty	Part Code
2.5" PLASTIC GROMMET	x1	2.5IN-GR-CAP
5/16-18 WING NUT	x6	5_16_18 WING NUT
5/16-18 X 2" STEEL STUD	x6	5_16_18X2 STUD
EXPANDING SPIGOT FOR 30MM TUBE	x6	ES-30
11 3/8" X 13 3/8" TABLET HOLDER (FOR GEN 2 & 3 ONLY)	x1	TABLET-HOLDER
STD-02 30MM BASE	x1	STD-02-BASE
FABRIC GRAPHIC FOR STD-02	x1	STD-02-G
450MM X 30MM END SECTION	x1	STD-02-T4
R1824MM X 30MM CURVED SECTION	x2	STD-02-T6
120MM X 30MM TUBES WITH (2) 100 X 100 MOUNTING PLATES	x1	STD-02-T1
75MM X 30MM CORNER SECTION LEFT SIDE	x1	STD-02-T2-L
75MM X 30MM CORNER SECTION RIGHT SIDE	x1	STD-02-T2-R
R1824MM X 30MM CURVED TOP SECTION	x1	STD-02-T3
30MM TUBING ADAPTOR WITH LOCK	x1	TC-30-L

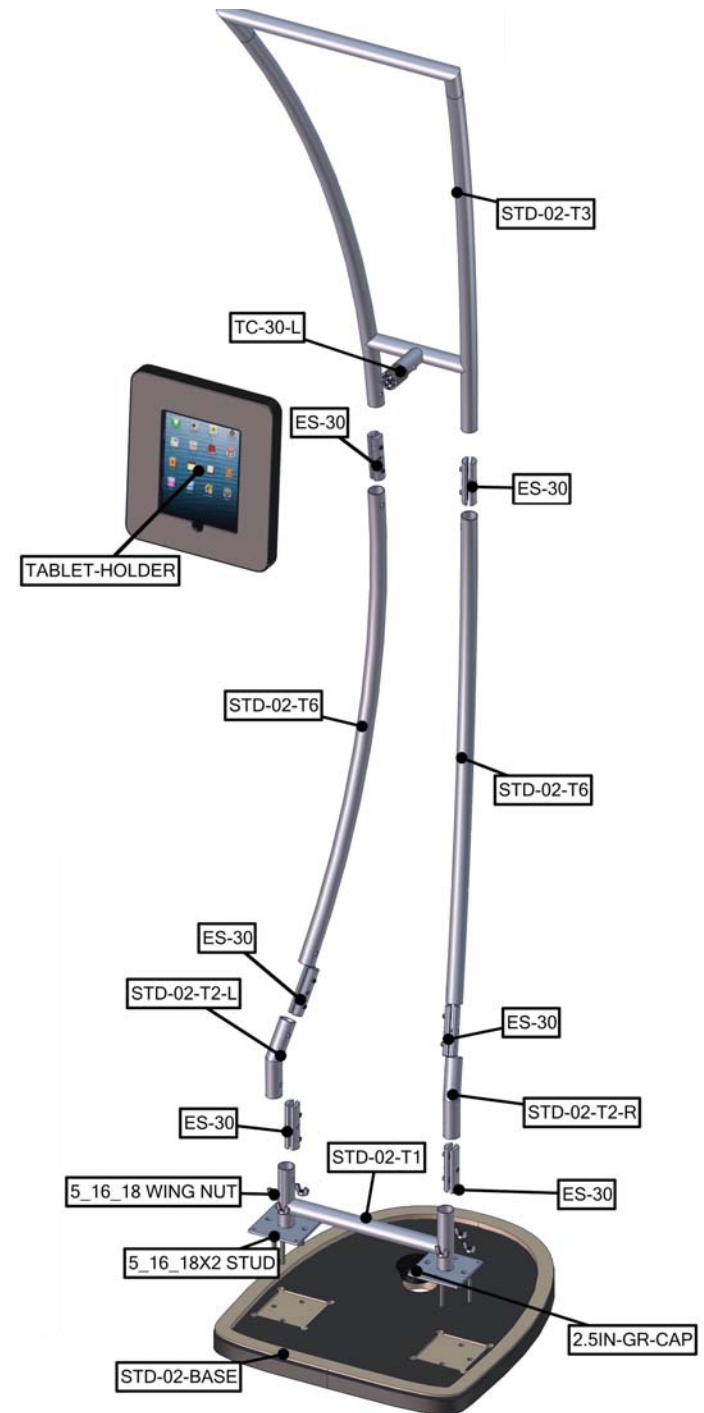
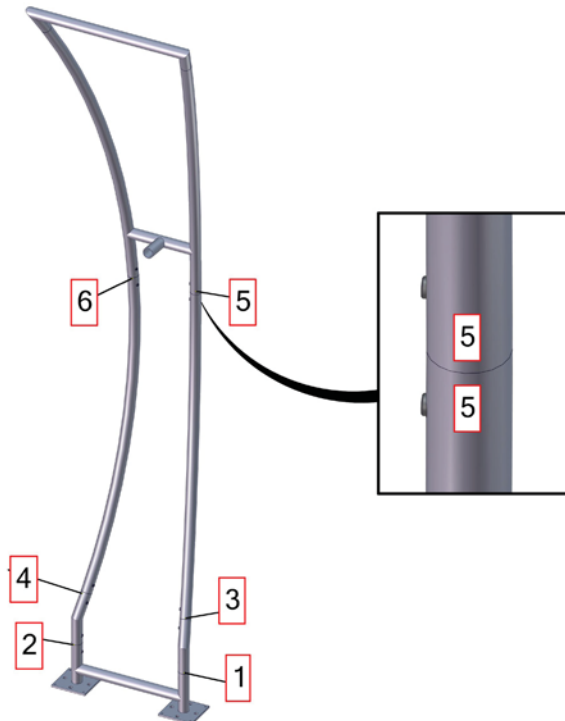

STEP 1: ASSEMBLE FRAME

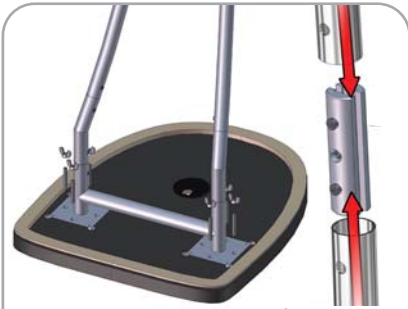

Connect bottom tubes following the labels by matching number to number. Slide joiner into tubing so hex screw sits in hole on tubing.

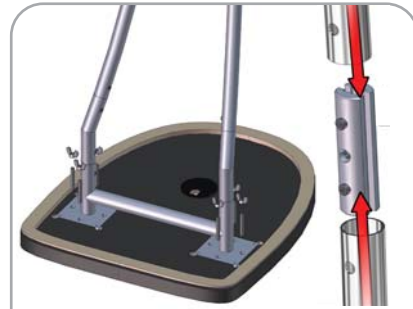

CONTINUED: Tighten the hex screw so the joiner separates and tightens against the inside of the tubing, locking the joiner & tubing together.

STEP 2: ATTACH BASE

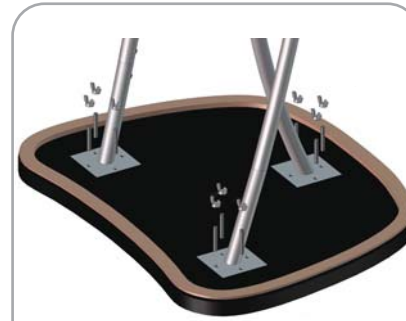

Attach base with wing nuts and stud. Insert threaded rods by hand.

STEP 3: ATTACH GRAPHIC



Pull graphic over top of frame.

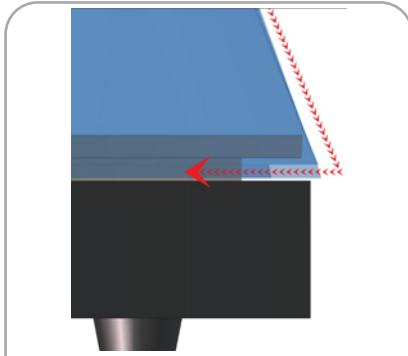

Push fabric into groove around base.



Continue around perimeter of base.

STEP 4: ASSEMBLE FRAME



After pulling over the graphic, assemble top of frame by locking the joiner and tubing together.

STEP 5: ZIP GRAPHIC



Pull fabric around top of frame and zip graphic closed.

STEP 6: INSTALL TABLET HOLDER

BACK VIEW

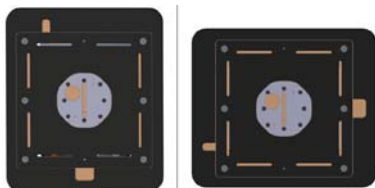

Portrait Orientation

Landscape Orientation

Choose orientation before attaching.

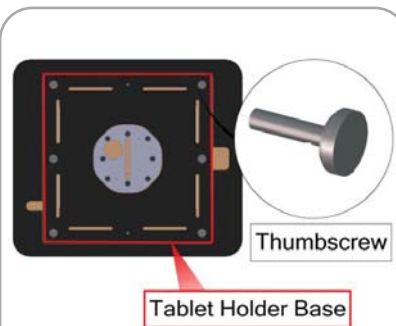

LANDSCAPE: Remove thumbscrews from back of tablet holder base.

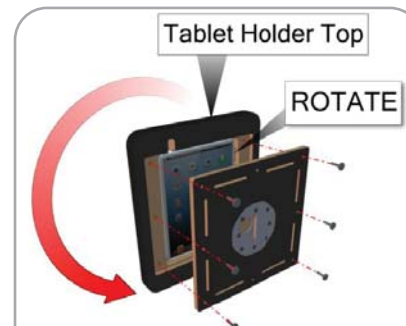

PORTRAIT: Remove thumbscrews. Rotate tablet holder top only 90°, so the tablet is vertical.

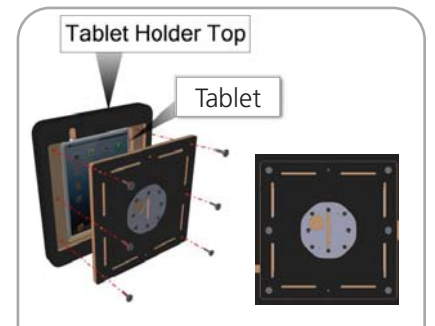

Place tablet into holder. Secure with thumbscrews. Plate on base must be vertical (as shown) to lock properly.

