

Cygnus

OR-K-SYG2

The Planetary line of Orbital Express Truss™ features over 40 professionally designed “off-the-shelf” kits for a variety of booth sizes and configurations. Each kit comes complete with all the parts, fixtures and fittings you need to create a successful exhibit, including (depending on the kit) low voltage spotlights and adjustable tabletops. A benefit to this versatile system is that it enables you to reconfigure kits in multiple ways and combinations using the same parts. Orbital Express Truss can also be easily customized!

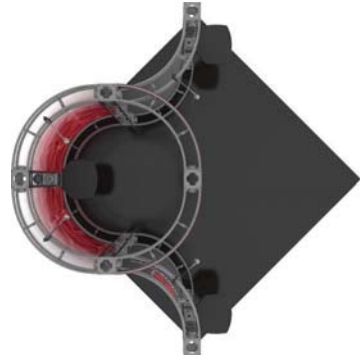

We are continually improving and modifying our product range and reserve the right to vary the specifications without prior notice. All dimensions and weights quoted are approximate and we accept no responsibility for variance. E&OE. See Graphic Templates for graphic bleed specifications.

features and benefits:

- Kit includes:
 - 10 x 6-way junction boxes
 - 5 x 36" straight truss lengths
 - 5 x 46" straight truss lengths
 - 10 x 90° curved truss lengths
 - 1 x full set of quicklock connectors
 - 3 x adjustable tabletops
 - 4 x 50 watt spotlights
 - 1 x OCT molded case
 - 1 x OCH2 molded case

dimensions:

Hardware:

Fits in a 10' x 10' space

Graphic with end caps:

Panels SYG1 & SYG4:
Total visual area: 39.5" w x 83.75" h

Panels SYG2 & SYG3:
Total visual area: 49" w x 90" h

Panels SYG5 & SYG6:
Total visual area: 47.25" w x 6" h

Shipping:

- 1 OCT case:
50"l x 47" w x 43" h
1270mm(l) x 1194mm(w) x 1092mm(h)
- 1 OCH2 case:
50"l x 30" h x 15" d
1270mm(l) x 762mm(h) x 381mm(d)

Approximate weight:
450 lbs / 204 kgs

*All dimensions available in millimeters
Please be sure to include a 2" bleed around perimeter.

Refer to related graphic template for specific information on sizes and bleeds. Dye-sublimated graphic require different bleed than UV.

Visit exhibitors-handbook.com/graphic-templates

additional information:

Graphic materials:
Dye sublimated or UV panels

Lumina 1, 50 watt spotlight

Tabletops (each): max weight
= 25 lbs / 11.34 kgs

*Kit does not include monitor or monitor mount

- Tabletop color options: (if applicable)

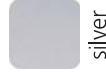

silver



black



mahogany



natural

CYGNUS PIECE COUNT:

OR-J-3
10



OR-J-DBL
2



OR-24-2
0

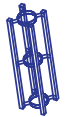

OR-30-2
0



OR-36-2
5

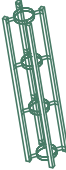

OR-46-2
5

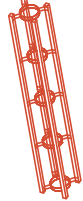

OR-45-CV-3
0



OR-90-CV-2
10



OR-B90
0



OR-B90A
0

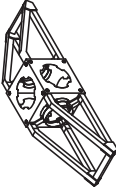

OR-B45
0

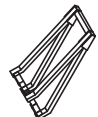

OR-TOOL-B
1



OR-QL-TZJ
33

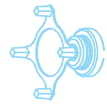

OR-QL-TZT
5

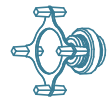

OR-UC-QL
0



OR-STG
0



OR-LCD1-B
0



OR-LCD2-B
0

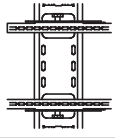

OR-LCD3-B
0

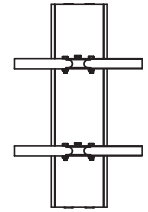

SPOTLIGHT
4

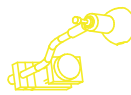

OR-TBL
3



OR-TBL2-L
0



OR-TBL2-R
0



OR-IS-24
0



OR-IS-36
0



OR-IS-46
0



OR-IS-48
0



OR-CIS-90
0



OR-SE-IS-90
0



OR-CIS-45
0



OR-ATL-CNTR
0

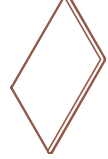

CYGNUS TABLETOP ACCESSORY PIECE COUNT:

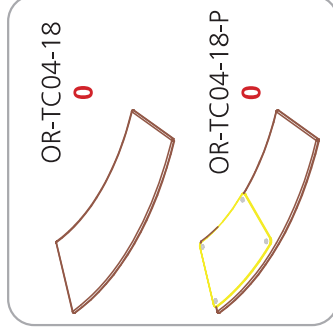
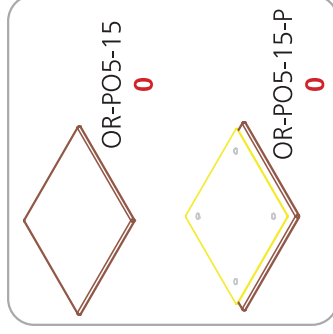
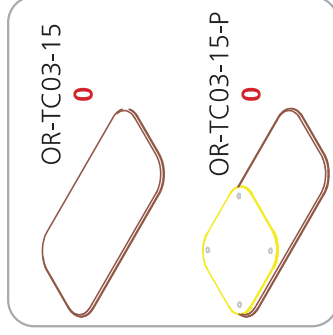
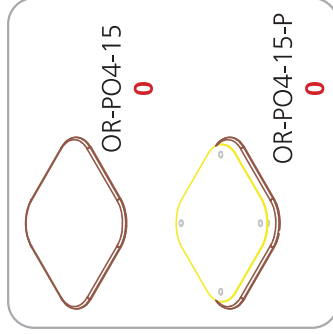
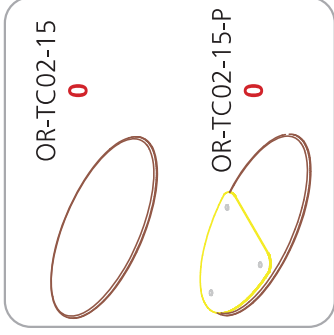
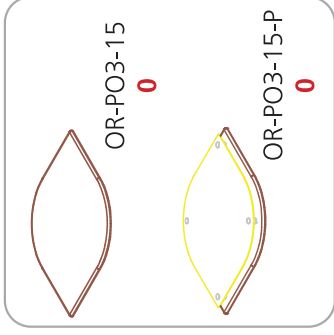
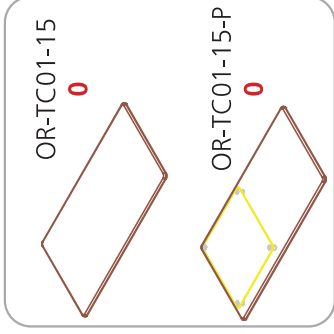
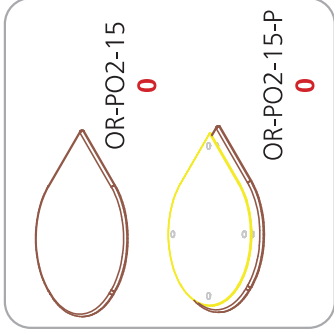
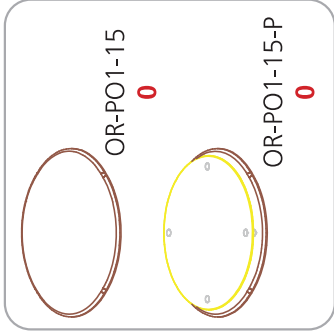

CYGNUS CASE COUNT:

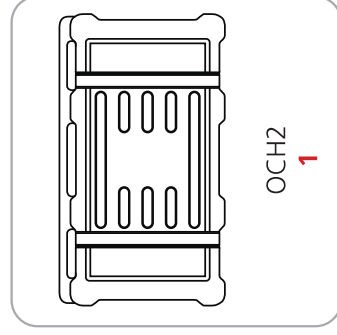
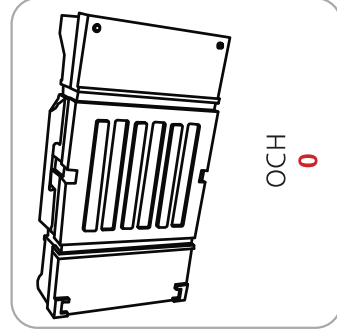
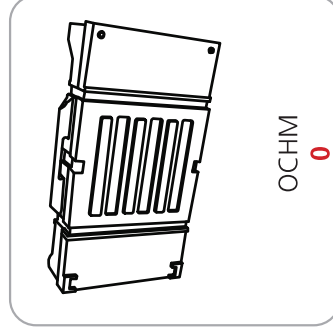
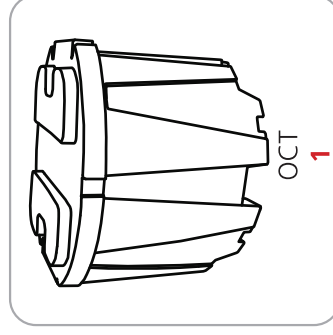
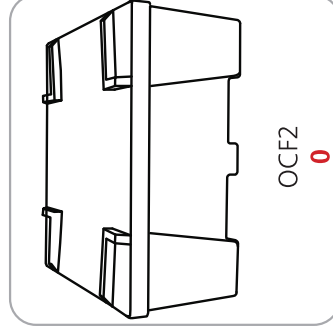
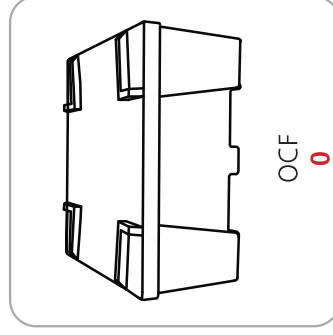
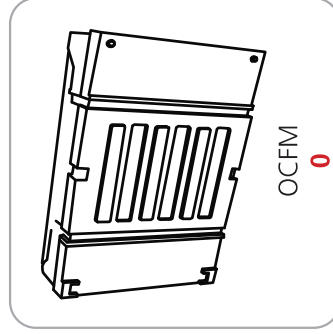

**CYGNUS GRAPHIC SPECS:
AVAILABLE GRAPHICS – UV & DYE SUBLIMATION**

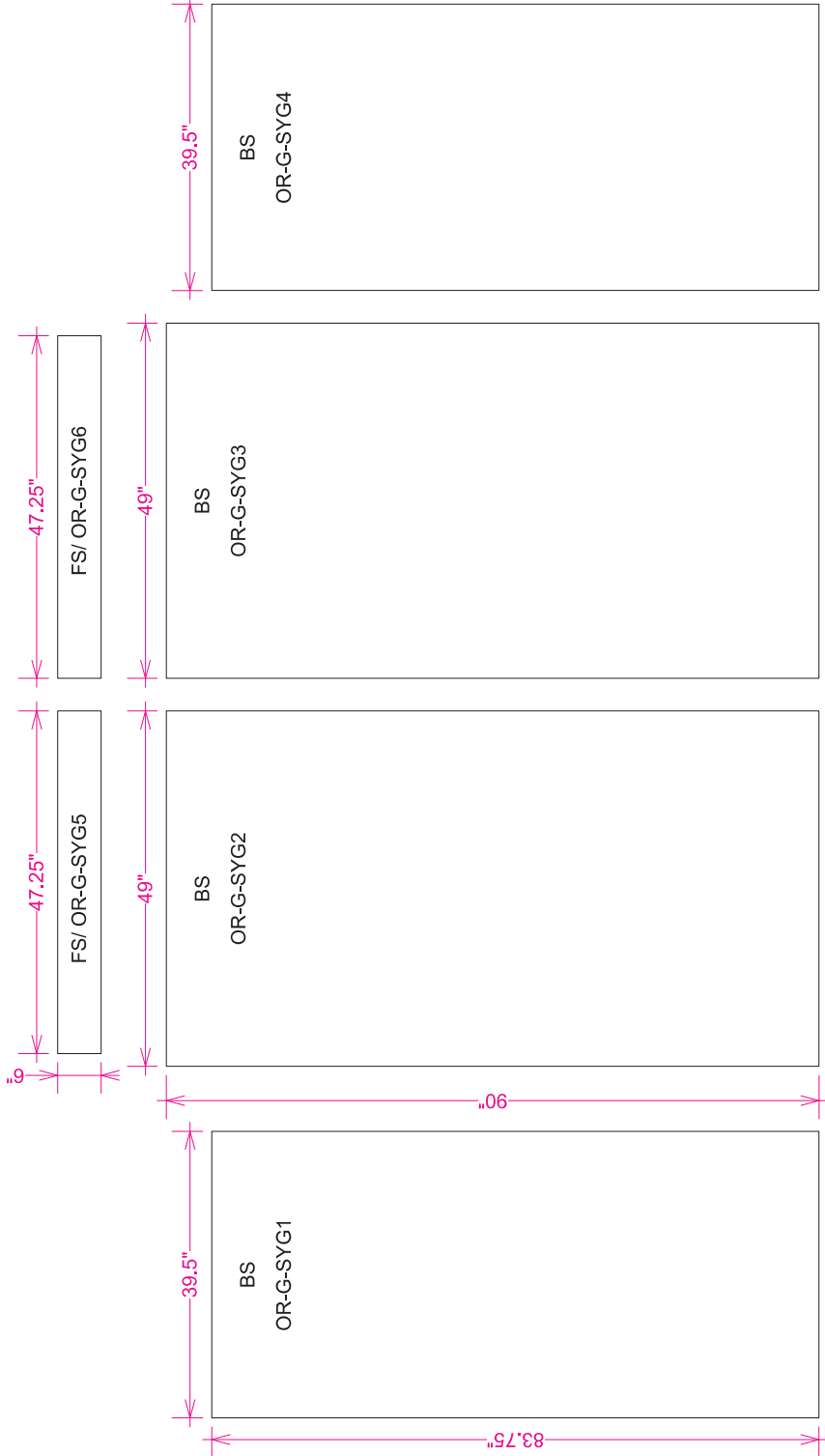

| | | | |
|--|---|---|---|
| <p>Acceptable File formats: Illustrator CS6 or below Photoshop CS6 or below Art time will be charged if files need to be fixed or altered to meet guidelines. When sending files please be sure to include all support art (fonts, linked images, etc.)</p> <p>Font Specifications: Fonts must be converted to outlines.</p> | <p>Bleeds: All orbital truss graphics require specifics bleeds. The sizes listed above represent the finished graphic size. Please keep all logos, type and critical information at least 1" in from each edge of the finished graphic.</p> <p>Dye Sublimation: 2" bleed around the perimeter. UV: 1/2" bleed around the perimeter.</p> | <p>Color: All files are printed as CMYK format. All critical Pantone colors need to be called out in the file or specified on the order as Coated or Uncoated swatches.</p> <p>Resolution: All raster files (either print files or linked files) must be at 100-120 pixels per inch at 100%</p> | <p>Finishing Details: When graphics are notched, a 7/8" square is cut in the appropriate location.</p> <p>FS: Graphics mounted to front of truss system BS: Graphics mounted to back of truss system</p> <p>Dye Sublimation graphics are attached to truss with velcro. UV panels are attached to truss with magnet.</p> |
|--|---|---|---|

To ensure quality, please note:

Each graphic has a specific code or number located on the graphic. The electronic print files provided must be named accordingly. Using this coding system will allow us to preflight and prepare your files for print more efficiently. **If you fail to provide your graphic files in this format, additional charges may be necessary to complete your printed materials.**

CYGNUS FLOOR PLAN:

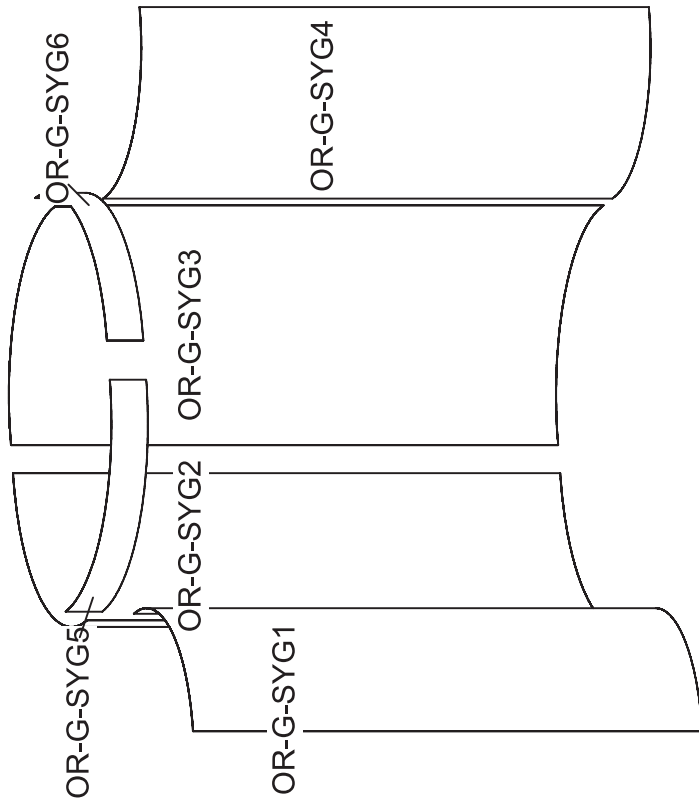

SCALE REF = 5ft



10' d X 10' w Inline

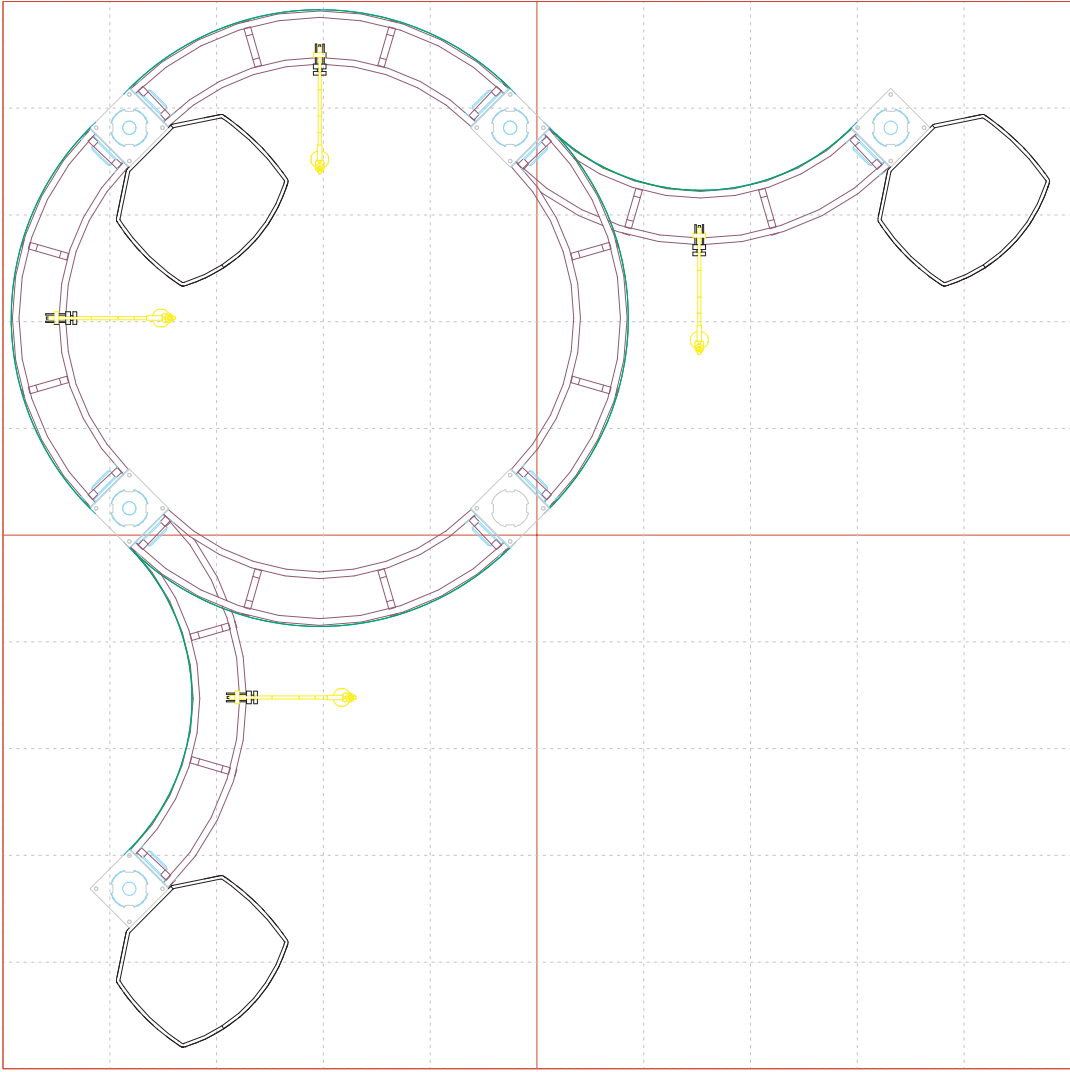

CYGNUS COLOR CODED PARTS:

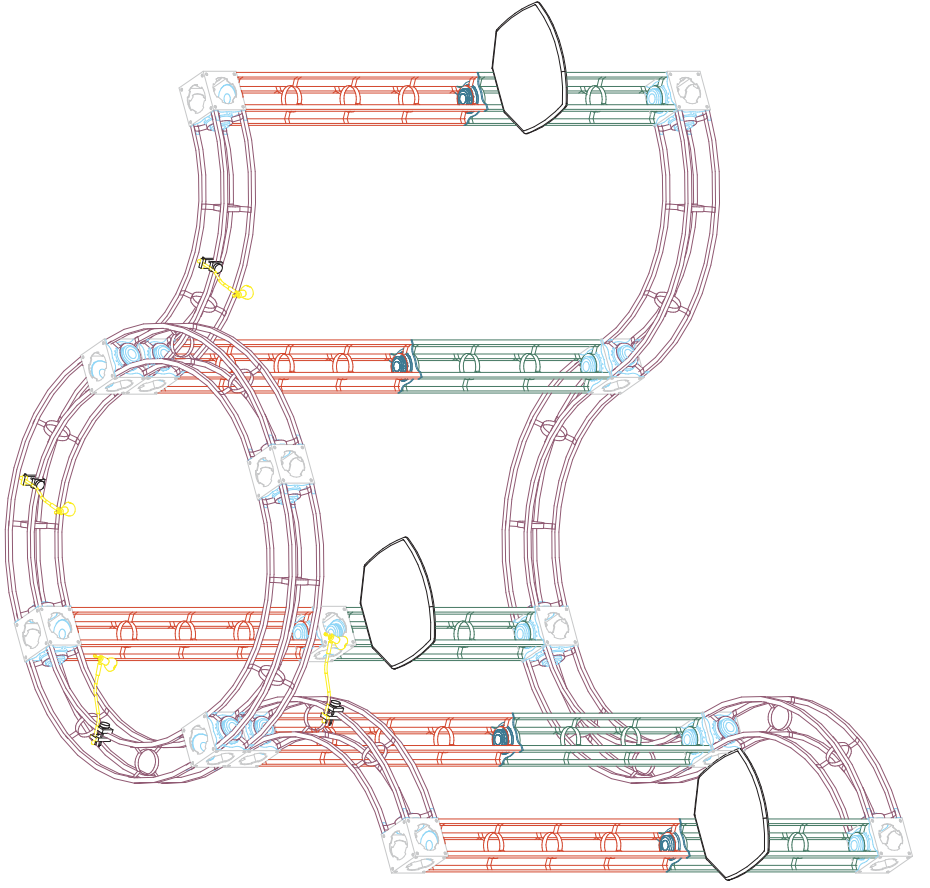
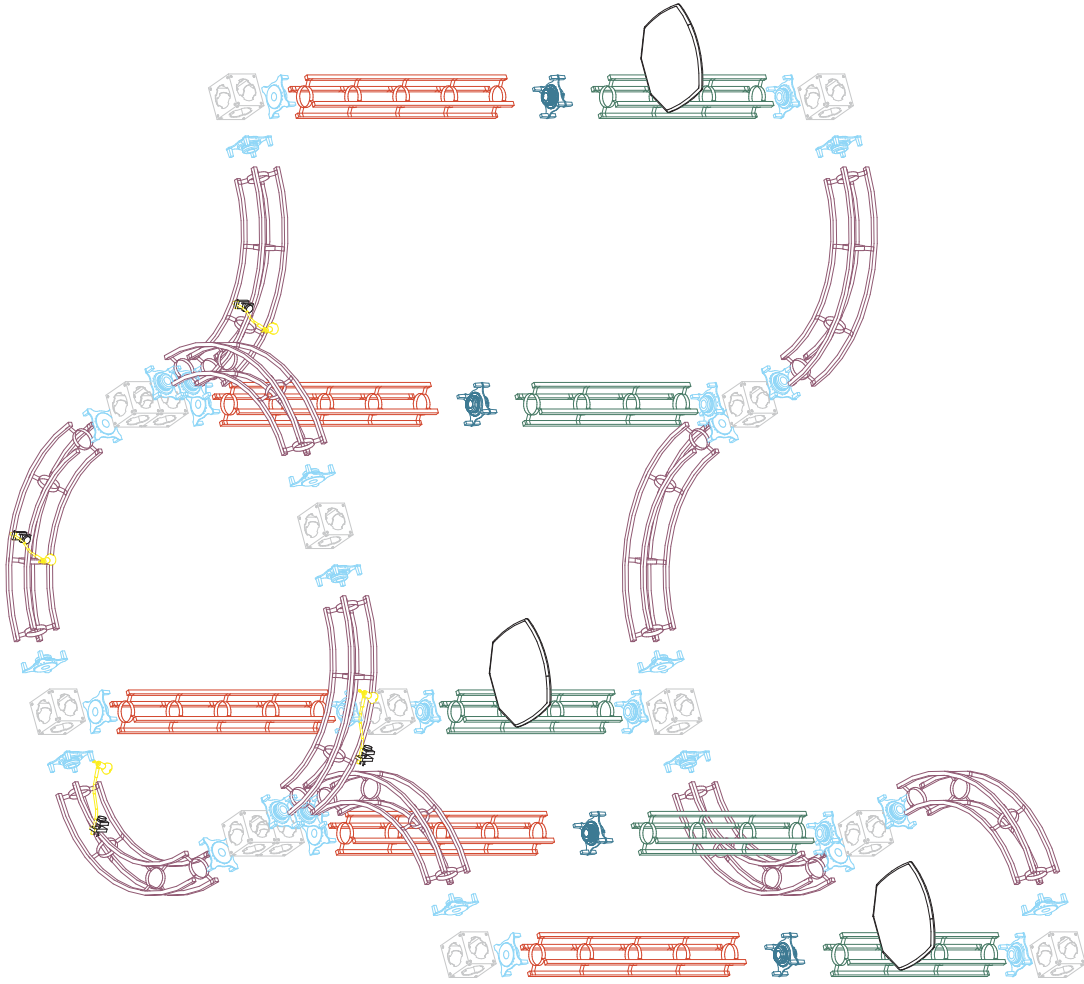

Parts exploded