



features & benefits

Here is a premier, heavy-duty panel kit for your displays. The Hero locks solidly together to give you a beefy wall to display your graphics and information. In either the Tabletop size or the Exhibit height, the Hero will save the day for your panel display needs.

Hero portable folding panels offer the convenience of folding panels with elegant, seamless panel construction. This system offers concealed hinges, lightweight durability and superb craftsmanship. Panels are constructed of an ultra light core material and covered on both sides with polyester fabric. Full height exhibits can be used separately as two tabletop units! The unique 2" radius curved ends lend a polished appearance.

Hero Kits

H01	H09
H02	H10
H02-2	H11
H03	H12-1
H04	H12-2
H05	H13
H06	H14
H07	H15-1
H08	H15-2

Assembly Instructions

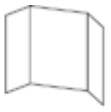

\$355.00

H01 Showcase
Kit includes: Self contained 3 panel folding system. Fabric one side, flame-retardant ABS with haircell finish on reverse, Includes strap closure, handle and shoulder strap
Dimensions: 30"h x 40"w x 11"d Weight: 13 lbs.

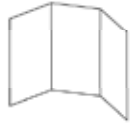

\$355.00

H02-1 6' Tabletop
Kit includes: 1-3 Panel base
Packing options: 1-Cardboard Box, 25 lbs. 1-Carry Bag, 22 lbs. 1-Molded Case 37 lbs.
Dimensions: 47 1/2"h x 58"w x 17"d Weight: 180 lbs.

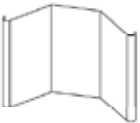

\$440.00

H02-2 6' Tabletop
Kit includes: 1-3 Panel base, 2-Curve panels
Packing options: 1-Cardboard Box, 30 lbs. 1-Molded Case 42 lbs.
Dimensions: 47 1/2"h x 63"w x 18"d



\$525.00

H03 6' Tabletop
Kit includes: 1-3 Panel base, 1-S. Header, 2-Lights
Packing options: 1-Cardboard Box, 34 lbs. 1-Molded Case 46 lbs.
Dimensions: 47 1/2"h x 58"w x 17"d



\$605.00

H04 6' Tabletop
Kit includes: 1-3 Panel base, 2-Curve panels, 1-S. header, 2-Lights
Packing options: 1-Cardboard Box, 39 lbs. 1-Molded Case 51 lbs.
Dimensions: 47 1/2"h x 63"w x 18"d

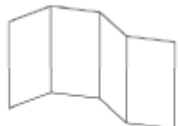

\$475.00

H05 8' Tabletop
Kit includes: 1-4 Panel base,
Packing options: 1-Cardboard Box, 37 lbs. 1-Carry Bag, 34 lbs. 1-Molded Case 49 lbs.
Dimensions: 47 1/2"h x 83"w x 17"d



\$640.00

H06 8' Tabletop
Kit includes: 1-4 Panel base, 1-S. header, 2-Lights
Packing options: 1-Cardboard Box, 46 lbs. 1-Molded Case 58 lbs.
Dimensions: 47 1/2"h x 83"w x 17"d

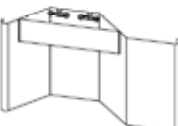

\$725.00

H07 8' Tabletop
Kit includes: 1-4 Panel base, 2-Curve panels, 1-S. header, 2-Lights
Packing options: Cardboard Box, 51 lbs. 1-Molded Case 63 lbs.
Dimensions: 47 1/2"h x 88"w x 18"d

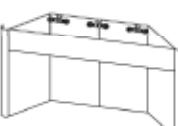

\$895.00

H08 8' Tabletop
Kit includes: 1-4 Panel base, 2-Curve panels, 1-L. header, 3-Lights
Packing options: Cardboard Box, 55 lbs. 1-Molded Case 67 lbs.
Dimensions: 47 1/2"h x 88"w x 18"d

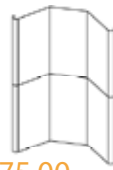

\$875.00

H09 6' Exhibit
Kit includes: 1-3 Panel base, 1-3 Panel top, 4-Curve panels
Packing options: 1-Cardboard Box, 48 lbs. 1-Molded Case 60 lbs.
Dimensions: 94 3/4"h x 63"w x 18"d



\$1,420.00

H10 8' Exhibit
Kit includes: 1-4 Panel base, 1-4 Panel top, 4-Curve panels, 1-L. header, 3-Lights
Packing options: 2-Cardboard Box, 96 lbs. 2-Molded Case 120 lbs.
Dimensions: 94 3/4"h x 88"w x 18"d

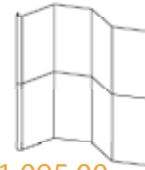

\$1,095.00

H11 8' Exhibit
Kit includes: 1-4 Panel base, 1-4 Panel top, 4-Curve panels
Packing options: 2-Cardboard Box, 83 lbs. 2-Molded Case 107 lbs.
Dimensions: 94 3/4"h x 88"w x 18"d



\$1,650.00

H12-1 10' Exhibit
Kit includes: 1-5 Panel base, 1-5 Panel top, 4-Curve panels, 1-L. header, 3-Lights
Packing options: 2-Cardboard Box, 108 lbs. 2-Molded Case 132 lbs.
Dimensions: 94 3/4"h x 110"w x 18"d



\$2,415.00

H12-2 10' Exhibit
Kit includes: 1-5 Panel base, 1-5 Panel top, 4-Curve panels, 1-L. header, 3-Lights, 1-Counter
Packing options: 3-Cardboard Box, 163 lbs. 3-Molded Case 199 lbs.
Dimensions: 94 3/4"h x 110"w x 18"d

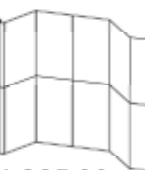

\$1,395.00

H13 10' Exhibit
Kit includes: 1-5 Panel base, 1-5 Panel top, 4-Curve panels
Packing options: 2-Cardboard Box, 95 lbs. 2-Molded Case 119 lbs.
Dimensions: 94 3/4"h x 110"w x 18"d

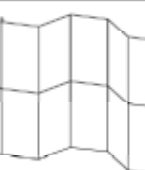

\$1,395.00

H14 Island Exhibit
Kit includes: 1-5 Panel base, 1-5 Panel top, 4-Curve panels
Packing options: 2-Cardboard Box, 95 lbs. 2-Molded Case 119 lbs.
Dimensions: 94 3/4"h x 110"w x 18"d



\$1,490.00

H15-1 10' Exhibit
Kit includes: 1-5 Panel base, 1-5 Panel top, 4-Curve panels, 1-S. header, 2-Lights
Packing options: 2-Cardboard Box, 104 lbs. 2-Molded Case 128 lbs.
Dimensions: 94 3/4"h x 110"w x 18"d

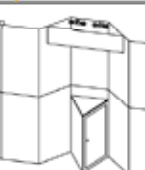

\$1,980.00

H15-2 10' Exhibit
Kit includes: 1-5 Panel base, 1-5 Panel top, 4-Curve panels, 1-S. header, 2-Lights, 1-Counter
Packing options: 3-Cardboard Box, 143 lbs. 3-Molded Case 186 lbs.
Dimensions: 94 3/4"h x 110"w x 18"d

Assembly Instructions

Hero Header Sizes

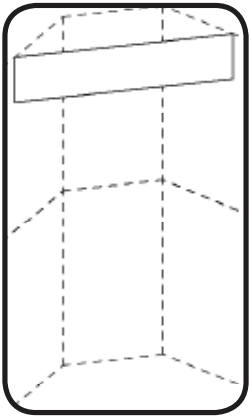

S. header

Dimen: 45" x 11 13/16"
Plex cut size: 11 23/32" x 44 7/8"
Graphic Substrate: Milk Plex
Weight: 4 lbs.

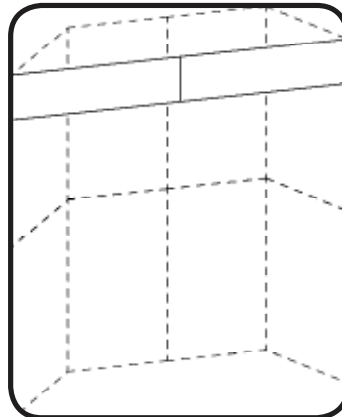

L. header

Dimen: 75" x 11 13/16"
Plex cut size: 11 23/32" x 37 15/32"
Graphic Substrate: Milk Plex
Weight: 6 lbs.

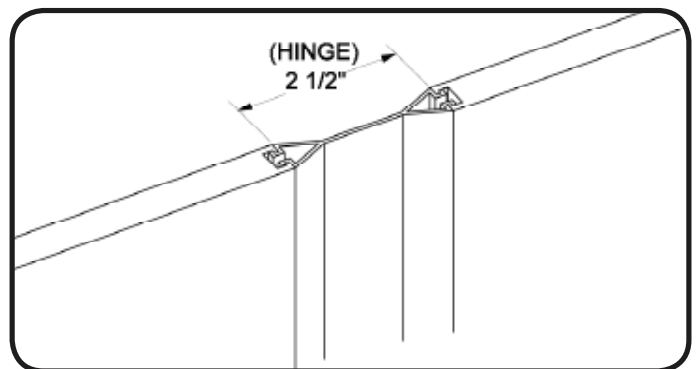
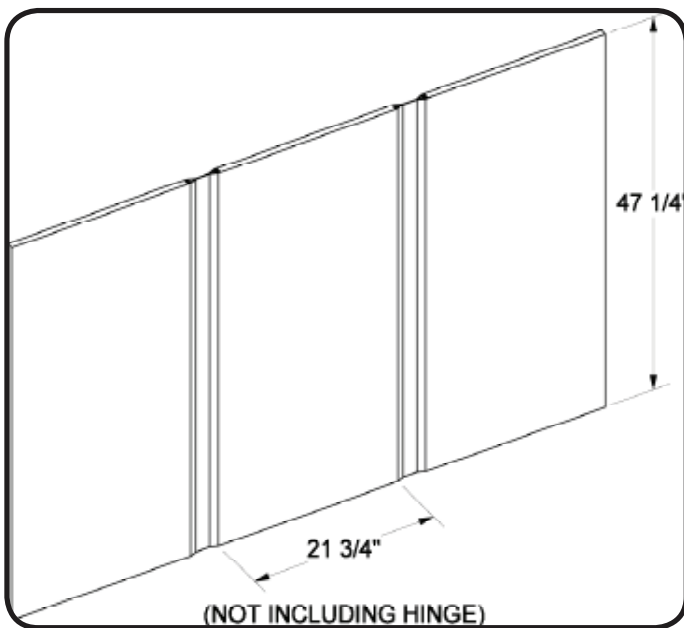
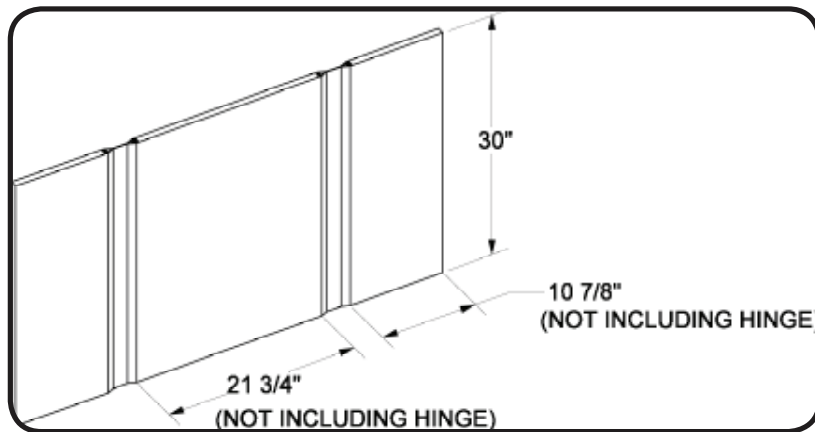

Hero Panel Sizes

Set-up Instructions

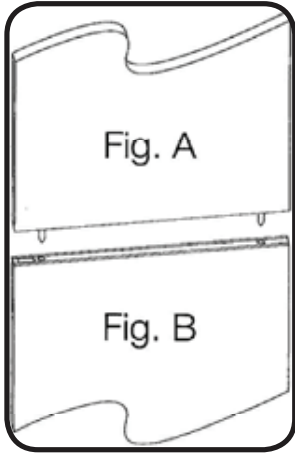

1 Assembly

There are two sets of panels in a full-height unit. A top section and a base section. The top section (figure A) has location pins along the base of the panels. The bottom section (figure B) has rubber feet along the bottom.

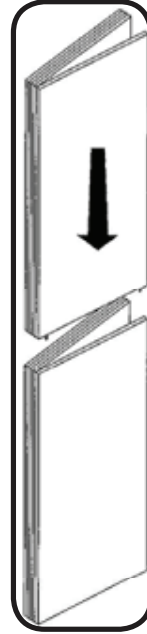

2 Stacking

There are two sets of panels in a full-height unit, a top section and a base section on the floor. Next, place base section on top of the top section, with the section (Fig. A) has pins facing downward, location pins along the top of the bottom base of the panels. The section and align pins bottom section (Fig. B) with pin holes on has rubber feet along bottom section. the bottom.

4 Add Optional Curved Panels

End flat panels have three connectors along the edge which attach curves. Attached curves by sliding cut-out sections of curve edge, located at dot position, over and down on panel connectors as shown.

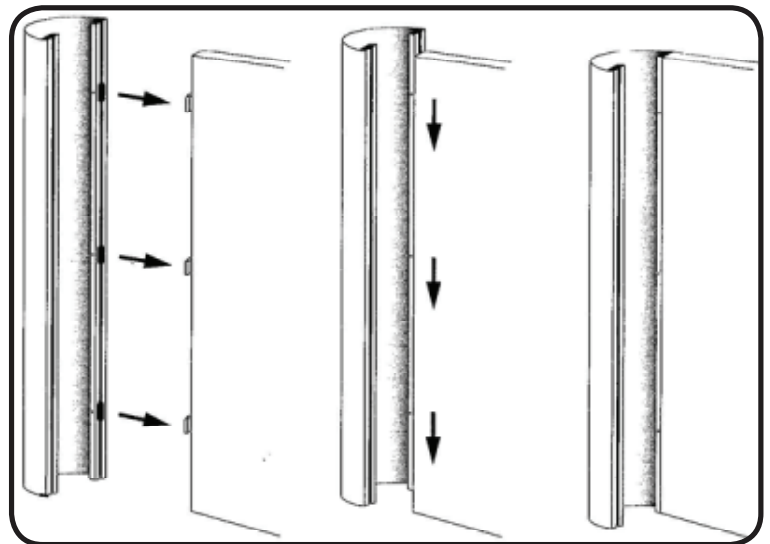
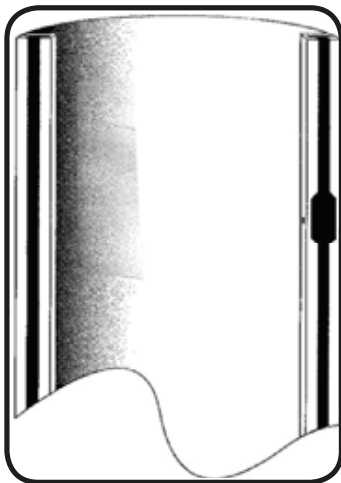

Assembly Instructions

3 Unfold Display

Unfold the display to the desired configuration by holding the bottom section and swinging outward in the direction of the arrows.

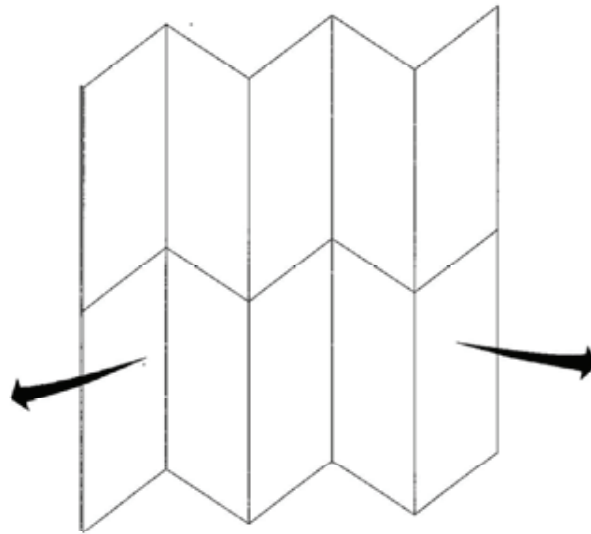

5 Add Accessories

Center the header on the display as desired and hang with attached header hooks.

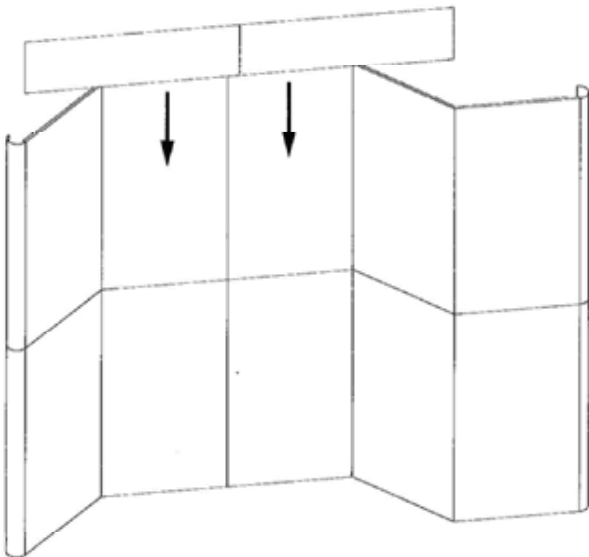

6 Packing

Careful repacking of your exhibit will lead to years of use.
Curves
Lights
Cardboard Panels

